

**LHD**

Left-hand drive / Fahrerseite links / Conduite à gauche / Conducción a la izquierda / Guida a sinistra / Stuur links / Høgerstyrd version / Venstrekørsel / Med rattet til venstre / Vasemmanpuoleinen liikenne / Volante à esquerda

Right-hand drive / Fahrerseite rechts

Conduite à droit / Conducción a la derecha / Guida a destra / Stuur rechts / Vänsterstyrd version / Højrekørsel / Med rattet til højre / Oikeanpuoleinen liikenne / Volante à direita

RHD**Installation instructions
for brackets****EN****Montageanleitung für
die Halterungen****DE****Instructions de montage
pattes****FR****Instrucciones de instalacion
de los estribos****ES****Istruzioni di montaggio
delle staffe****IT**

Please consult the website for
instructions in the languages:
NL-SV-DA-NO-FI-PT

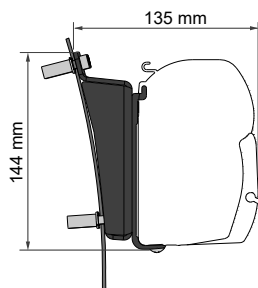

KIT FORD TRANSIT H3

98655Z176**98655Z177**

F45s (L2/L3 - 350)
(L4 - 450)





A REAR
98655Z176
1x

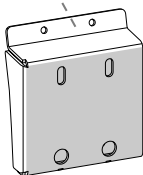

A REAR
98655Z177
1x

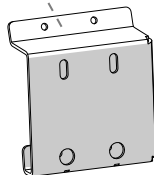

C FRONT
98655Z176
1x

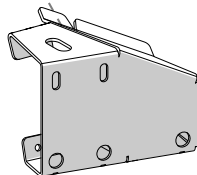

C FRONT
98655Z177
1x

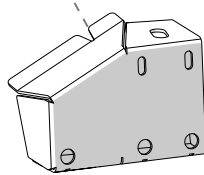

B 1x

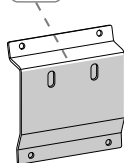

D 2x

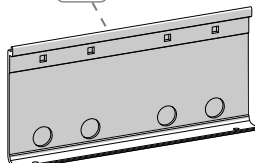

E 1x

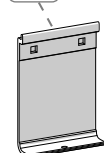

F M6x16
UNI 5931
12x



G NUTSERT
12x

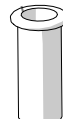

H M6x16
UNI 5732
6x

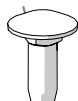

I M6
6x



L 6,4x12,5x1,6
UNI 6592
6x



M M5x14
3x



N M5x14
3x



Package contents / Verpackungsinhalt / Contenu de l'emballage / Contenido del embalaje / Contenuto dell'imballo

p. 2

Installation instructions / Montageanleitung / Instructions de montage / Instrucciones de montaje / Istruzioni di montaggio

p. 4

Safety instructions / Sicherheitshinweise / Consignes de sécurité / Instrucciones de seguridad / Avvertenze di sicurezza

p. 14

Warranty / Garantie / Garantie / Garantía / Garanzia

p. 15



- EN** Check that nothing has been damaged or deformed during transport. In the event of doubts or questions concerning the installation, use or limitations of the product, contact the dealer. **We recommend that the installation is carried out by qualified personnel and in compliance with current local regulations.**
- DE** Bitte kontrollieren Sie, dass alle Einzelteile einwandfrei sind und nicht während dem Transport beschädigt wurden. Im Zweifelsfall oder bei Fragen zur Montage, Verwendung oder zu Einschränkungen des Produkts wenden Sie sich bitte an den Händler. **Wir empfehlen die Anbringung durch Fachpersonal in Übereinstimmung mit den geltenden lokalen Vorschriften vornehmen zu lassen.**
- FR** Contrôler le contenu du colis et vérifier qu'aucune pièce n'ait été cassée ou déformée durant le transport. En cas de doutes ou de questions relatives à l'installation, l'utilisation du produit, contactez le concessionnaire. **L'installation doit être réalisée par des personnes dûment qualifiées et conformément aux normes en vigueur dans le pays d'installation.**
- ES** Controlar que ningún detalle se haya roto o deformado durante el transporte. En caso de dudas o si tiene alguna pregunta sobre el montaje, uso y limitaciones del producto, póngase en contacto con el distribuidor. **Recomendamos que la instalación se realice por personal cualificado en conformidad con las regulaciones locales.**
- IT** Controllare che nessun particolare sia rotto o deformato a causa di errori di trasporto. In caso di dubbi o domande relative al montaggio, utilizzo e limiti del prodotto, contattare il rivenditore. **Consigliamo di far eseguire l'installazione da parte di personale qualificato ed in conformità alle vigenti normative locali.**
-

- EN** **ATTENTION: INSTALLATION ON FIXING KIT**
The awnings are to be fixed on the brackets so that the words "SUPPORT" on the awning are in correspondence of the brackets: this condition is necessary and indispensable for the two brackets situated at the extremities (which are located on the fixing point of the arms on the case-box). It is important, but not indispensable, for the central bracket/s as it/they provide/s only a mounting support. The brackets must always be well-aligned to each other to avoid later problems; in case they are not, they must be properly shimmed using the spacers to ensure the alignment.
The installation of the awning can occur only when the adapter is perfectly aligned to the wall of the vehicle.

- DE** **ACHTUNG: ANBRINGUNG AUF BEFESTIGUNGSKIT**
Die Markisen werden so auf die Halterungen angebracht, dass sich die Aufschrift "SUPPORT", auf der Rückseite der Markise, in gleicher Höhe zu den Halterungen befindet: diese Voraussetzung ist wichtig und verbindlich hinsichtlich der beiden äusseren Halterungen (welche sich in Höhe des Befestigungspunktes des Gelenkarmes am Gehäuse befinden). Dies ist wichtig aber nicht verbindlich für die zentral positionierten Halterungen, welche als Unterstützung dienen. Die Halterungen müssen immer gleichlinig angebracht sein; sollte dies nicht der Fall sein, dann mit Distanzstücken ausgleichen.
Die Anbringung der Markise kann nur durch geradlinig anliegenden Adapter an der Fahrzeugwand erfolgen.

- FR** **ATTENTION : INSTALLATION SUR KIT DE FIXATION**
Les stores doivent être montés sur les étriers de manière à ce que les inscriptions "SUPPORT" du store se trouvent au même niveau des étriers : condition importante et fondamentale pour les deux étriers situés aux extrémités (qui se trouvent au même niveau du point de fixation du bras sur le boîtier du store). Condition importante mais non fondamentale pour l'étrier/les étriers du milieu dont la fonction est de simple support. Les étriers doivent toujours être alignés entre eux pour éviter d'éventuels problèmes. Dans le cas contraire, donner éventuellement plus d'épaisseur à l'aide d'entretoises garantissant leur bon alignement. L'installation du store pourra se faire seulement une fois que l'adaptateur sera parfaitement aligné contre la paroi du véhicule.



ES

IMPORTANTE: INSTALACION EN KIT DE FIJACION

Los toldos deben fijarse en los soportes de manera que las palabras "SUPPORT" en el toldo estén en correspondencia con los estribos: esta condición es importante y vinculante para los dos soportes en los extremos (que se encuentran en correspondencia con el punto de fijación de los brazos en el armazón). Es importante, pero no vinculante, para el/los soporte/s central que es/son solo de apoyo.

Los soportes deben estar siempre bien alineados entre ellos para evitar problemas posteriores; en caso contrario, suplementar adecuadamente utilizando los espaciadores para asegurar la alineación.

La instalación del toldo sólo puede ocurrir con el adaptador perfectamente alineado a la pared del vehículo.

IT

IMPORTANTE: INSTALLAZIONE SU KIT DI FISSAGGIO

I tendalini vanno fissati sulle staffe facendo in modo che le scritte "SUPPORT" sul tendalino si trovino in corrispondenza delle staffe: questa condizione è importante e vinculante per le due staffe poste alle estremità (che si trovano in corrispondenza al punto di fissaggio delle braccia sul cassonetto).

È importante, ma non vinculante, per la/e staffa/e centrali dove la presenza è di semplice supporto.

Le staffe devono sempre essere ben allineate tra loro per evitare successivi problemi; in caso non lo fossero, spessorare opportunamente utilizzando dei distanziali per garantire l'allineamento.

L'installazione del tendalino può avvenire solo ad adapter perfettamente allineato alla parete del veicolo.

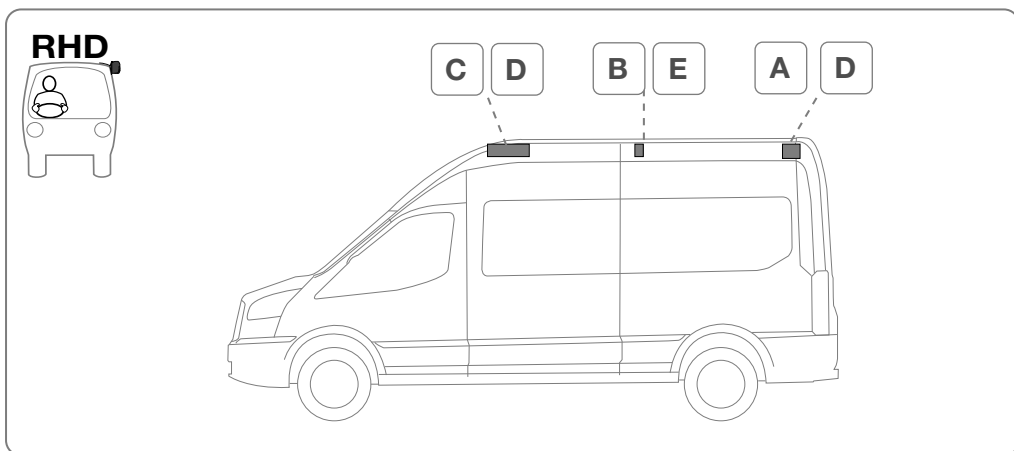
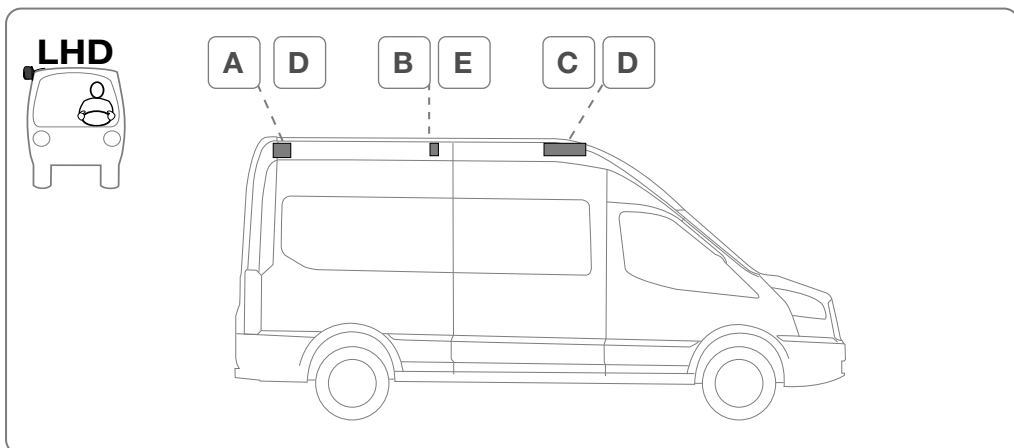



1A L2 - 350

LHD

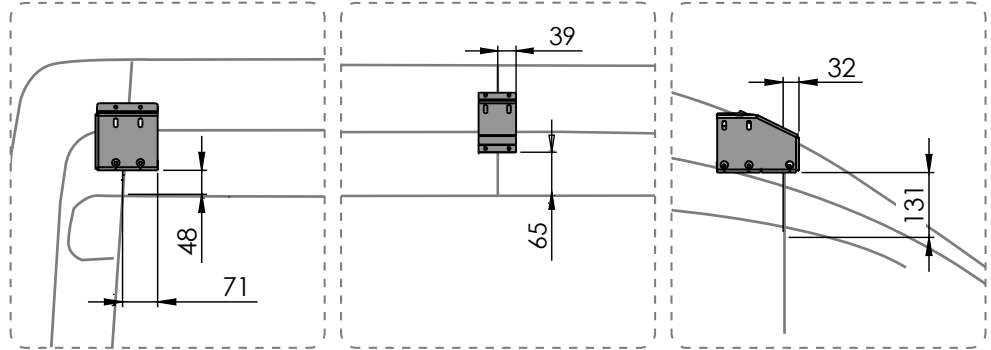
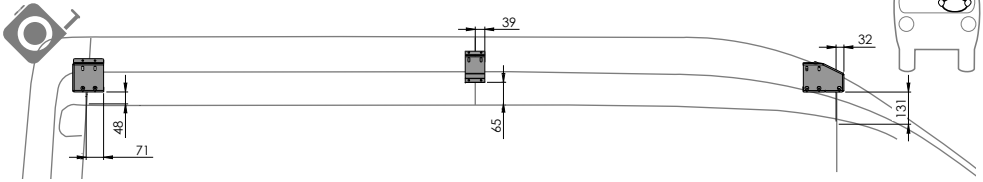

1B L2 - 350

RHD

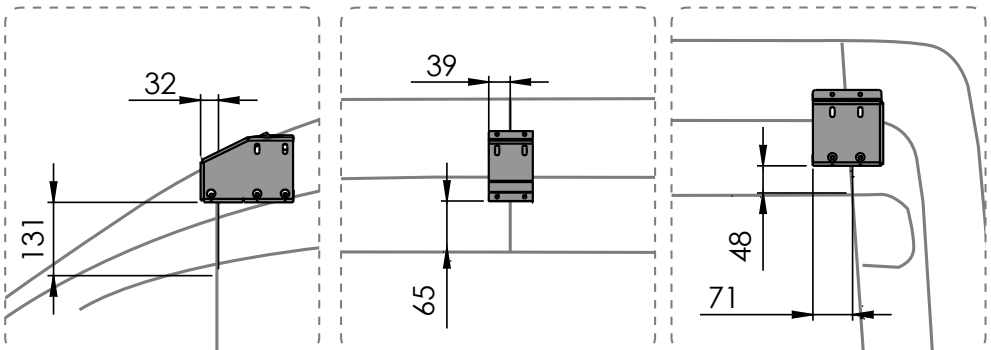
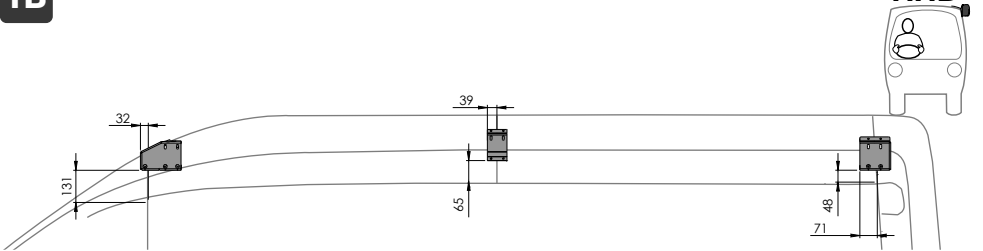



2A L3 - 350
L4 - 450

LHD

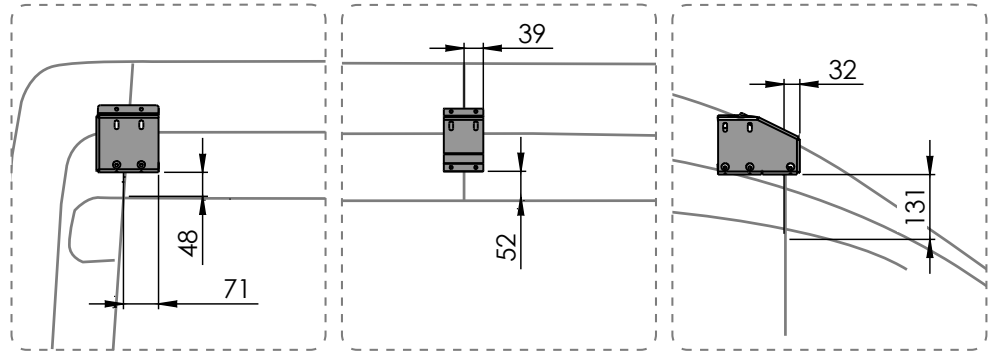
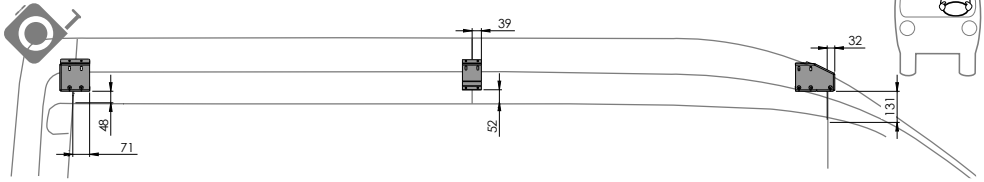

2B L3 - 350
L4 - 450

RHD

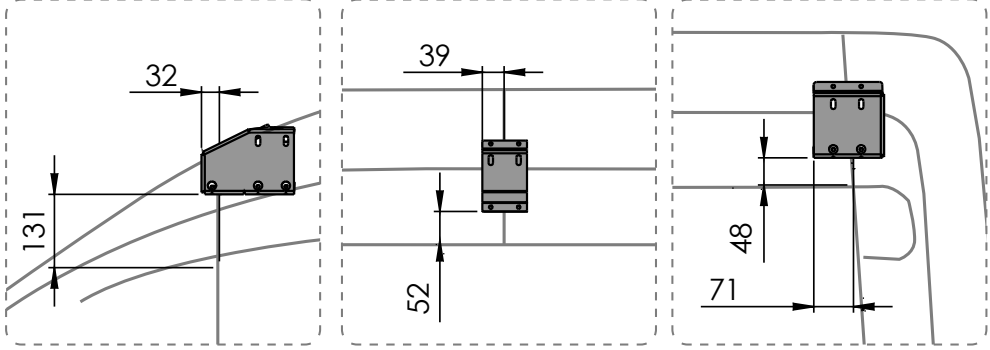
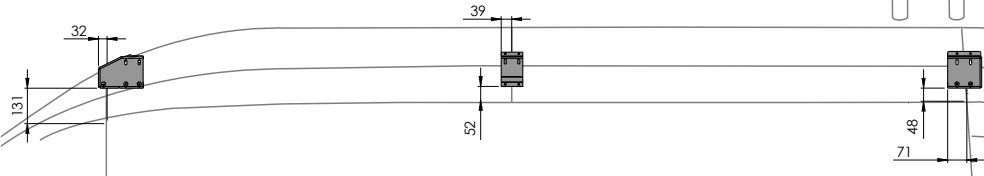



3A

LHD

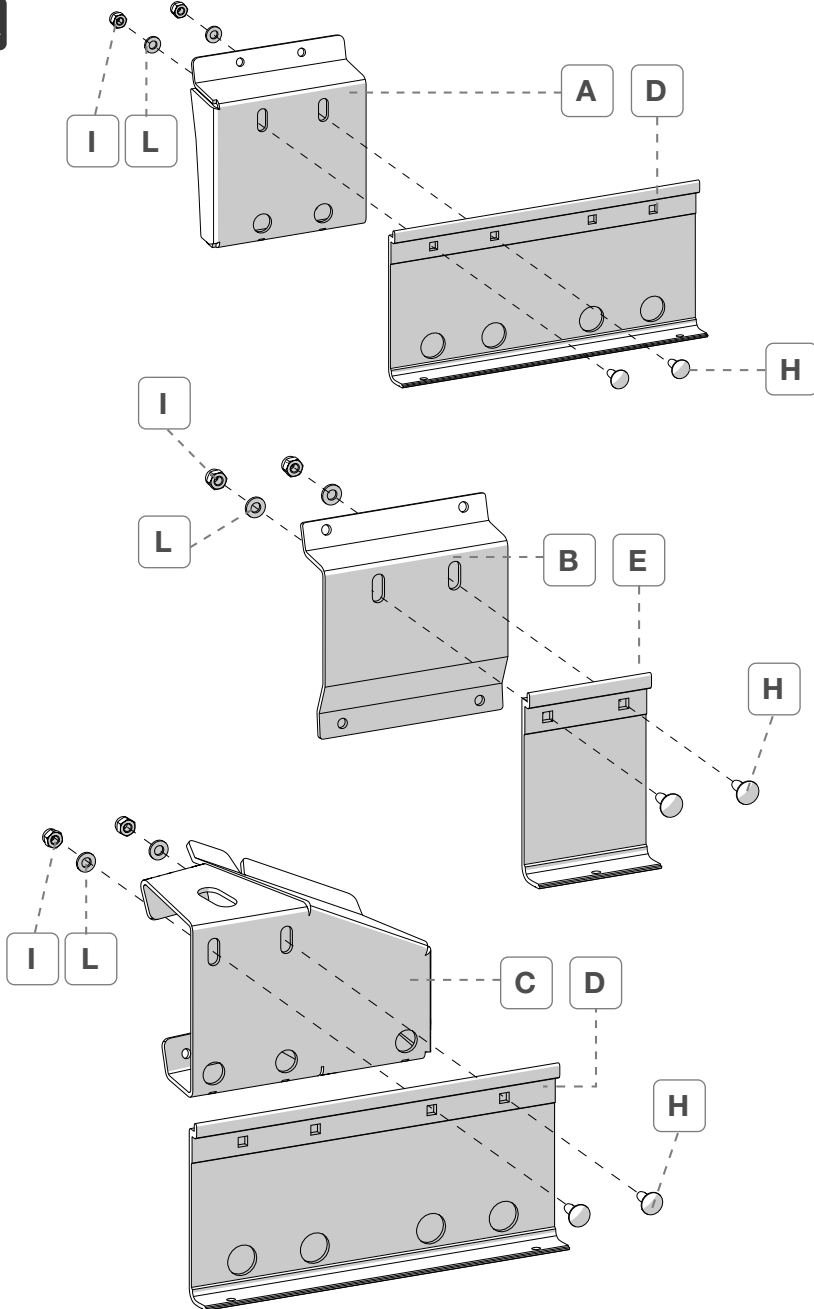
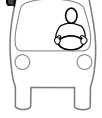



3B

RHD

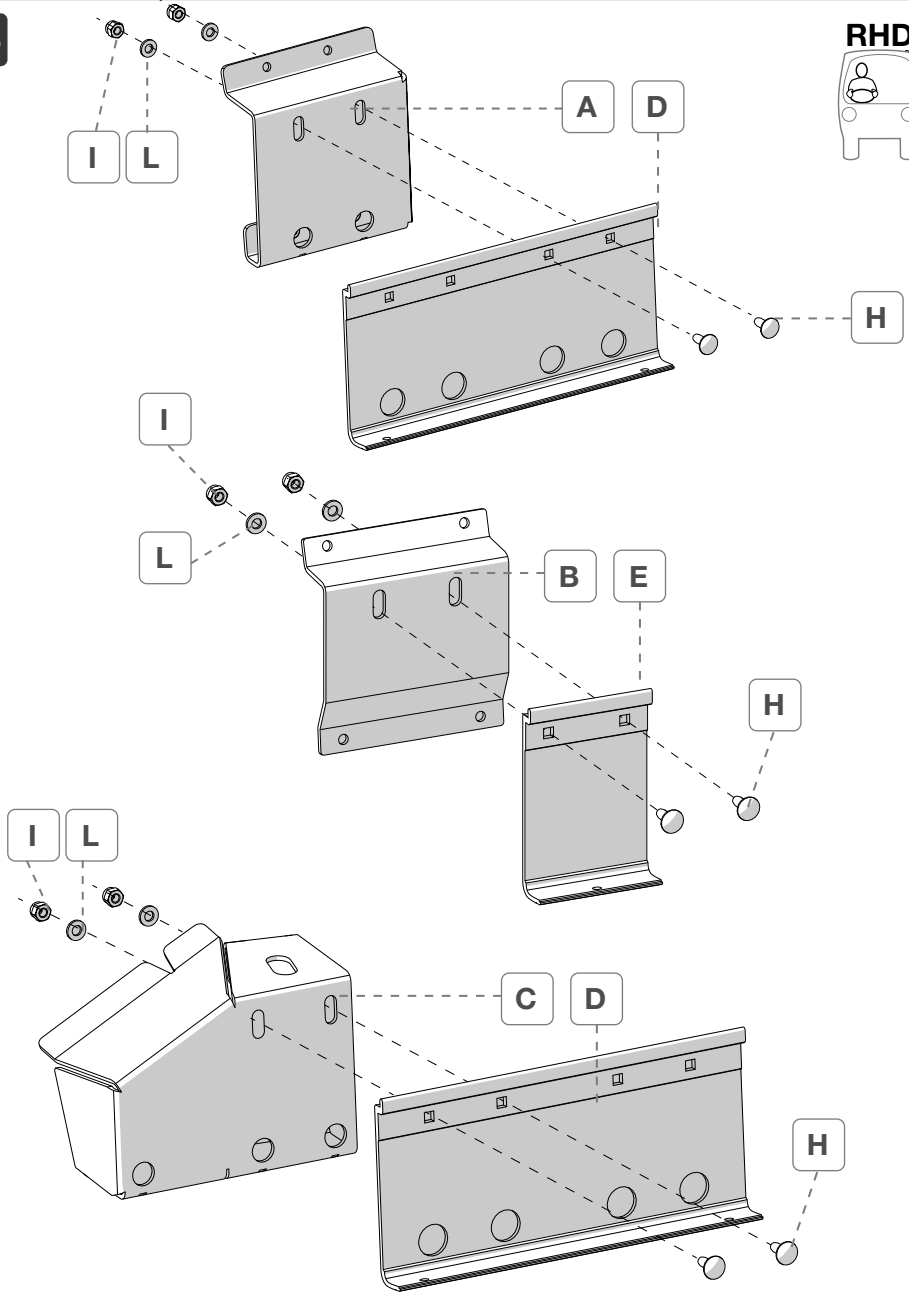
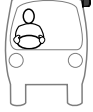



4A

REAR

LHD

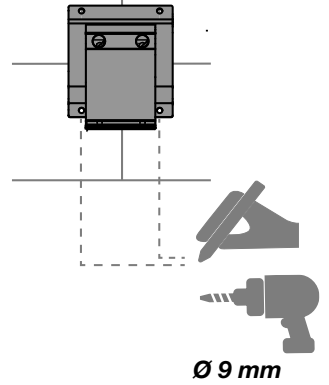
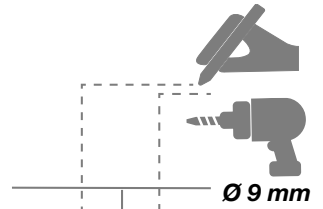
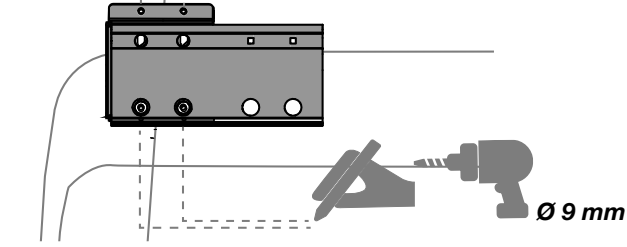
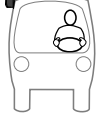

FRONT

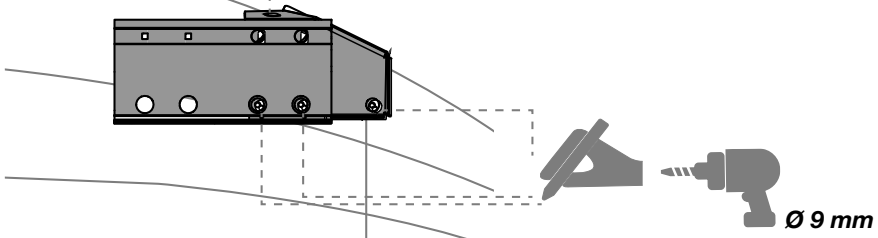



4B

REAR

RHD

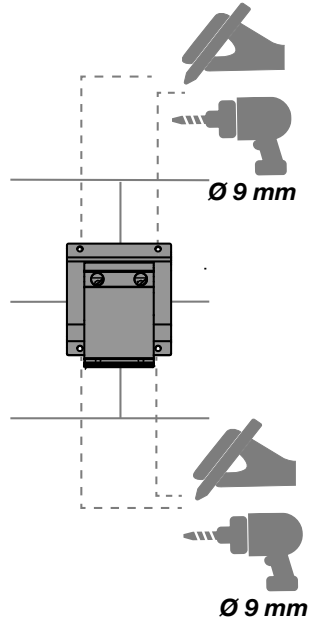
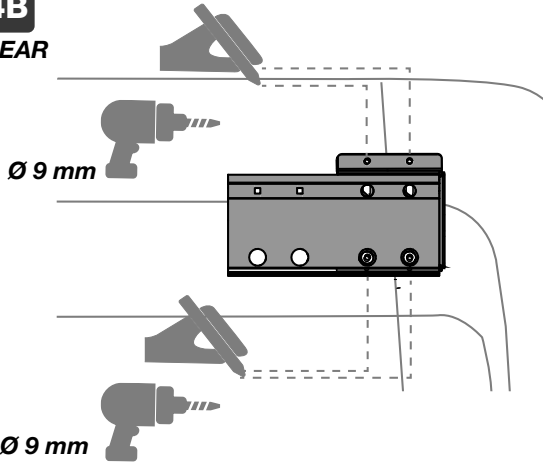
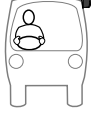

FRONT

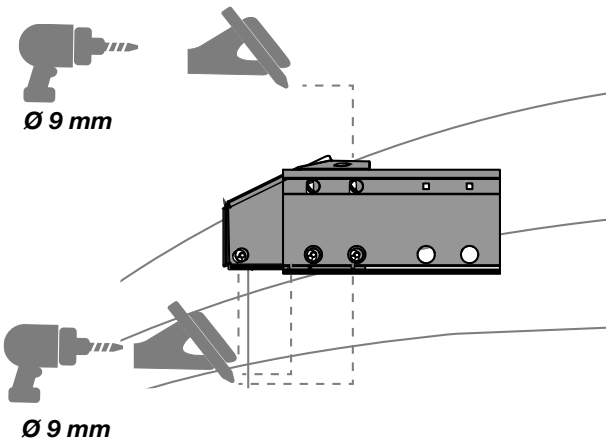



5

I

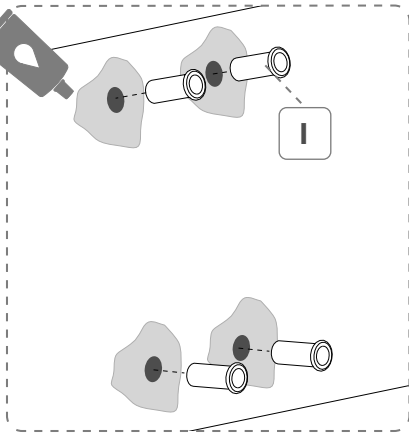
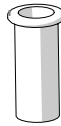
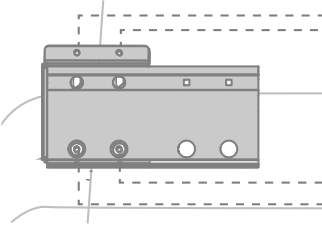
**SIKA 252****EN****Important:** use of SIKA 252 adhesive is essential for fixing the bracket (brackets).**DE****Wichtig:** Zur Befestigung des Bügel (bzw. der Bügel) unbedingt SIKA-Dichtungsmasse 252 benutzen.**FR****Attention:** l'utilisation du mastic SIKA 252 est fortement recommandée pour coller la patte de fixation (les pattes de fixation).**ES****Importante:** es fundamental usar el adhesivo SIKA 252 para fijar el soporte (los soportes).**IT****Importante:** è fondamentale l'utilizzo dell'adesivo SIKA 252 nel fissaggio della staffa (delle staffe).**REAR LHD**

4x

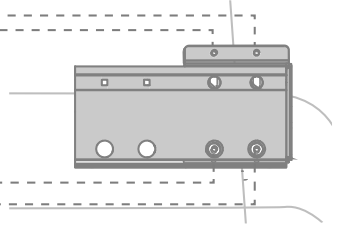
REAR RHD

4x

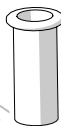
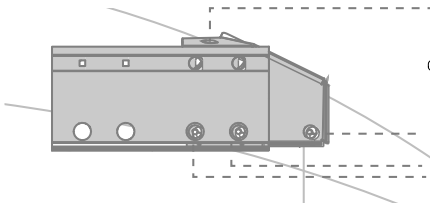
FRONT LHD

4x

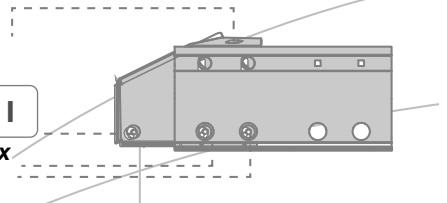
FRONT RHD



6

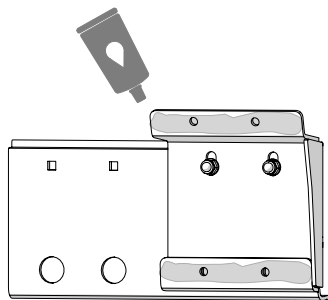
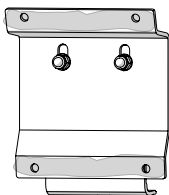
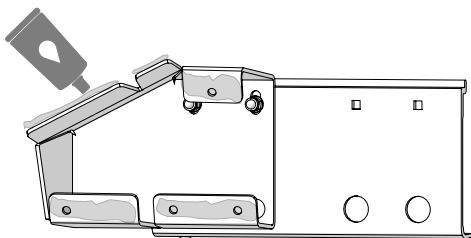

SIKA 252

EN

Important: use of SIKA 252 adhesive is essential for fixing the bracket (brackets).

DE

Wichtig: Zur Befestigung des Bügels (bzw. der Bügel) unbedingt SIKA-Dichtungsmasse 252 benutzen.

FR

Attention: l'utilisation du mastic SIKA 252 est fortement recommandée pour coller la patte de fixation (les pattes de fixation).

ES

Importante: es fundamental usar el adhesivo SIKA 252 para fijar el soporte (los soportes).

IT

Importante: è fondamentale l'utilizzo dell'adesivo SIKA 252 nel fissaggio della staffa (delle staffe).

7A

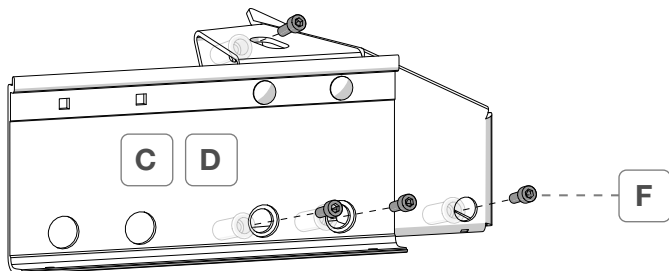
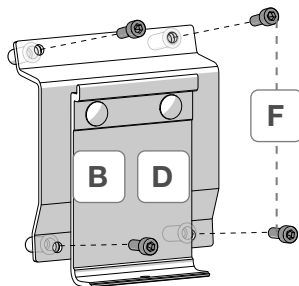
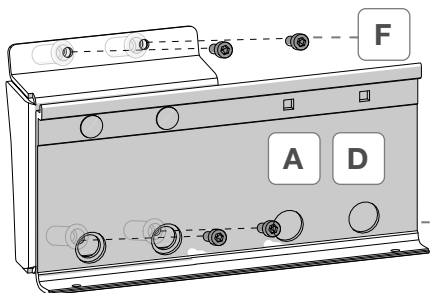

LHD





7B

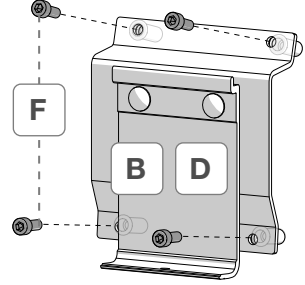
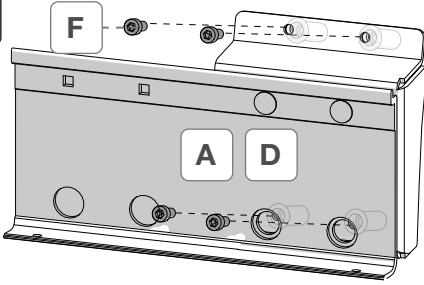

RHD

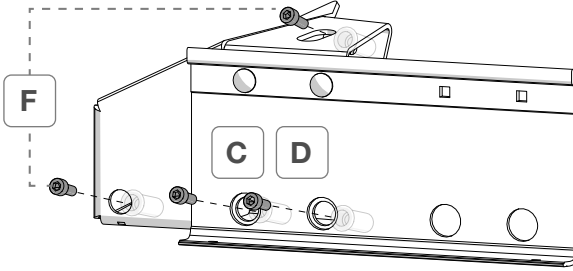
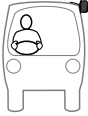

8

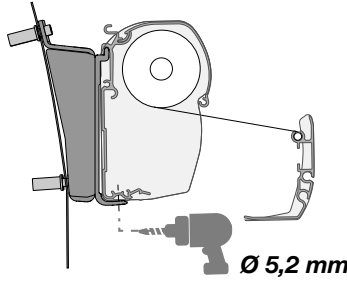
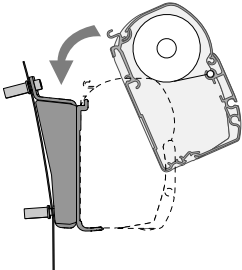

2x

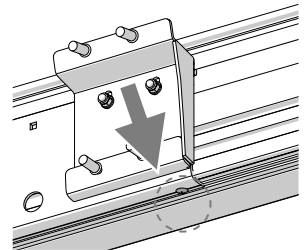
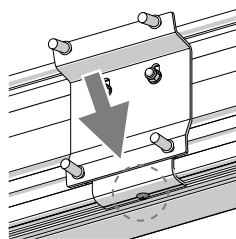
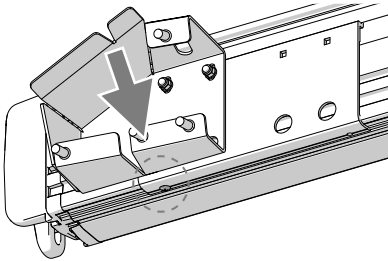
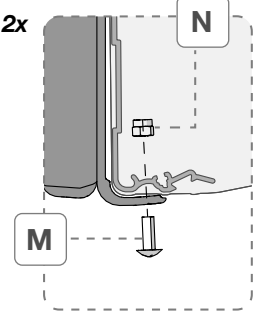



EN **ATTENTION** Periodically check the brackets to make sure they are firmly attached (especially after the first kilometers) make sure the bolts are not loose and that holding brackets have not shifted.

DE **ACHTUNG** Regelmässig die Befestigung der Halterungen kontrollieren. Achten Sie vor allem nach dem ersten Sicherstellen darauf, dass sich die Haltebügel nicht verschoben haben.

FR **ATTENTION** Contrôler périodiquement l'état de fixation des pattes (surtout après les premiers kilomètres) en s'assurant que les supports de fixation n'aient pas bougé.

ES **CAUIDADO** Controlar periodicamente el estado de fijación de los estribos (sobretudo después de los primeros Kms) asegurándose que no se desplacen.

IT **ATTENZIONE** Controllare periodicamente lo stato di fissaggio delle staffe (soprattutto dopo i primi chilometri) assicurandosi che le stesse non si siano mosse e che i serraggi siano corretti.

EN When using the awning please follow the instructions of the product.

ES Para el uso del toldo, atenerse a las instrucciones que se encuentran en el producto.

DE Bitte halten Sie sich beim Gebrauch der Markise an die Gebrauchsanweisung.

IT Per l'utilizzo del tendalino, attenersi alle istruzioni presenti nel prodotto.

FR Pour l'utilisation du store, se référer aux instructions du store même.

EN Read the following instructions and warnings carefully; failure to observe these installation and usage instructions as well as the laws for driving in the relevant country may cause severe harm or damage for which the manufacturer declines all responsibility. Before installation, ensure compatibility with the vehicle on which the product must be installed. Checking that the wall/roof/rear door is sufficiently solid and suitable for guaranteeing the resistance of the anchoring points is always mandatory. If not, strength and compliance with the maximum load indicated in the instructions are not guaranteed and it will be necessary to reinforce it these points. In the event of an accident involving the vehicle and/or the product, ensure that the product has not been damaged. In the event of damage, contact your local retailer before moving the vehicle. Fiamma declines every responsibility for any modification of the product that may cause damage and/or injury to things and people.

DE Lesen Sie sich die folgenden Anweisungen und Warnhinweise sorgfältig durch. Die Nichtbeachtung dieser Montage- und Nutzungsvorschriften sowie der Bestimmungen der Straßenverkehrsordnung im Einsatzland kann zu schwerwiegenden Schäden führen, für die der Hersteller keine Verantwortung übernimmt. Vergewissern Sie sich im Vorfeld der Montage, dass das Produkt mit dem Fahrzeug, an dem es installiert werden soll, kompatibel ist. Prüfen Sie unbedingt stets, dass die Fahrzeugwand/-dach/-tür ausreichend stabil und geeignet ist, um die Festigkeit der Ankerpunkte zu gewährleisten. Nach einem eventuellen Unfall, der das Fahrzeug bzw. Produkt betrifft, immer sicherstellen, dass das Produkt nicht beschädigt wurde. Im Falle von Schäden wende man sich vor der Benutzung des Fahrzeugs an den Händler. Fiamma lehnt jede Verantwortung für Veränderungen am Produkt ab, die zu Schäden und/oder Verletzungen an Sachen und Personen führen können.



FR

Lire attentivement les instructions de montage suivantes. Le non-respect de ces conseils d'installation ou d'utilisation mais aussi des normes relatives au code de la route du pays dans lequel vous circulez peuvent causer de graves dommages qui ne pourront aucunement engager la responsabilité du fabricant. Avant de procéder au montage, assurez-vous de la compatibilité du produit devant être installé sur le véhicule. Il est obligatoire de vérifier que la paroi / le toit / le hayon du véhicule est suffisamment solide ou qu'elle/il est adapté/e pour garantir la résistance des points de fixation. En cas d'accident impliquant le véhicule et/ou le produit, vérifiez que le produit n'a pas été endommagé. Dans le cas contraire, contacter le concessionnaire avant de déplacer le véhicule. Fiamma décline toute responsabilité quant aux éventuelles modifications apportées au produit pouvant entraîner des dommages et/ou lésions aux choses et aux personnes

ES

Lea atentamente las siguientes instrucciones y advertencias; el incumplimiento de estas normas de montaje y uso y de las normas del código de circulación del país por el que se circula puede causar daños graves sobre los que el fabricante declina toda responsabilidad. Antes del montaje, asegúrese de que el producto sea compatible con el vehículo en el que se instalará. Es obligatorio comprobar siempre la solidez suficiente de la pared/techo/portón del vehículo y que sea adecuada para garantizar la resistencia de los puntos de anclaje. En caso de accidente que afecte al vehículo o al producto, asegúrese de que el producto no haya sufrido daños. Si hay algún daño, póngase en contacto con su distribuidor local antes de mover el vehículo. Fiamma no se hace responsable de cualquier modificación del producto que pueda causar daños o lesiones a cosas y personas.

IT

Leggere con attenzione le seguenti istruzioni e avvertenze; il mancato rispetto di queste norme di montaggio e utilizzo nonché delle normative del codice stradale del paese di circolazione possono causare gravi danni in ordine ai quali la ditta produttrice declina ogni responsabilità. Prima del montaggio assicurarsi la compatibilità con il veicolo sul quale il prodotto deve essere installato. È obbligatorio verificare sempre la sufficiente solidità della parete/tetto/portellone del veicolo e che essa/ sia idonea a garantire la resistenza dei punti di ancoraggio. In caso di incidente riguardante il veicolo e/o il prodotto, assicurarsi che il prodotto non abbia subito danni. In caso di danno, contattare il rivenditore locale prima di spostare il veicolo. Fiamma declina ogni responsabilità per qualsiasi modifica del prodotto che possa causare danni e/o lesioni a cose e persone.

EN

Warranty Fiamma

In case of defects with regards to materials and manufacturing, the customer is entitled to the warranty in accordance with local laws and regulations of the country in which the product was purchased.

DE

Garantie Fiamma

Im Falle einer Mangelhaftigkeit der Ware, kann der Verbraucher unter den erforderlichen Voraussetzungen gegenüber dem Verkäufer von dem Garantieanspruch zu den festgelegten Bedingungen gemäss den lokalen Rechtsvorschriften Gebrauch machen.

FR

Garantie Fiamma

En cas d'un défaut de conformité du produit, le consommateur pourra faire valoir ses droits de recours en garantie selon les modalités prévues par les dispositions légales locales, pour autant que les conditions de recours soient satisfaites.

ES

Garantía Fiamma

En caso de fallos o defectos de material y de fabricación, el cliente puede hacer valer la garantía de acuerdo con las leyes y reglamentaciones del país en el que el producto haya sido comprado.

IT

Garanzia Fiamma

In caso di difetto di conformità dei beni, il consumatore potrà far valere nei confronti del venditore la garanzia secondo le modalità previste dalle disposizioni di legge locali, ove ne ricorrano i presupposti.



fiamma.com

Fiamma S.p.A. - Italy

Via San Rocco, 56
21010 Cardano al Campo (VA)



All rights reserved.

Fiamma S.p.A.

reserves the right to modify at any time,
without notice, prices, materials,
specifications and models or to cease
production of any model.